

2SC2230(A)

/ Descriptions

KF S) CD E GE

/ Features

M_{<F} #

/ Applications

#

/ Equivalent Circuit

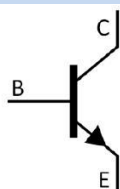

/ Pinning



/ h_{FE} Classifications & Marking

2SC2230(A)

/ Electrical Characteristic Curve

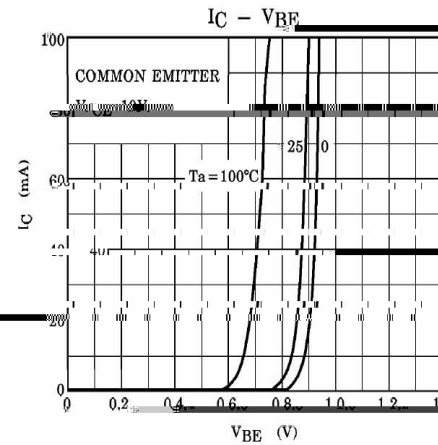
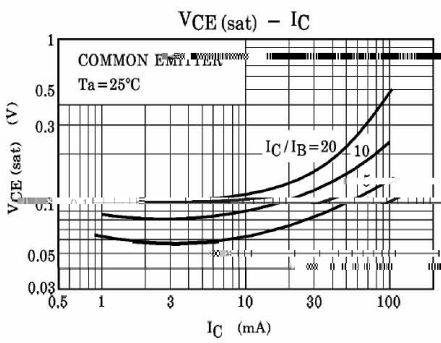
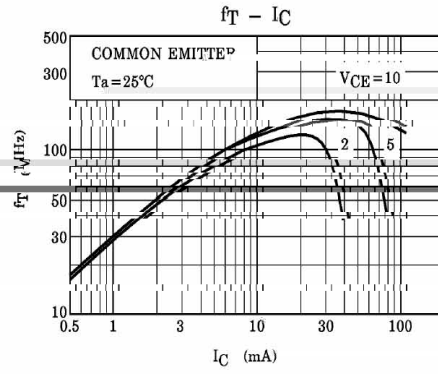
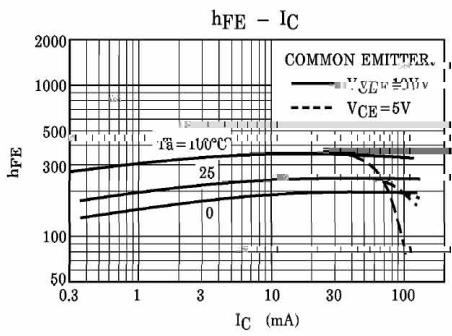
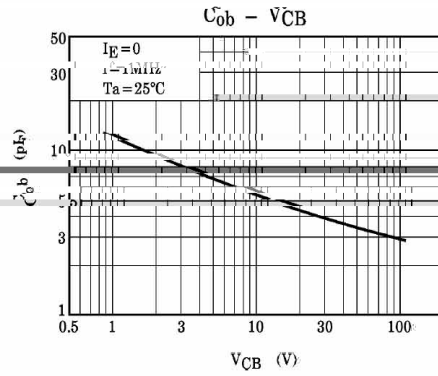
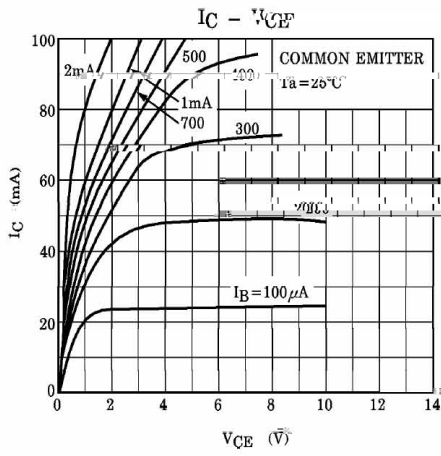

/ Package Dimensions

TO-92LM

Unit: mm

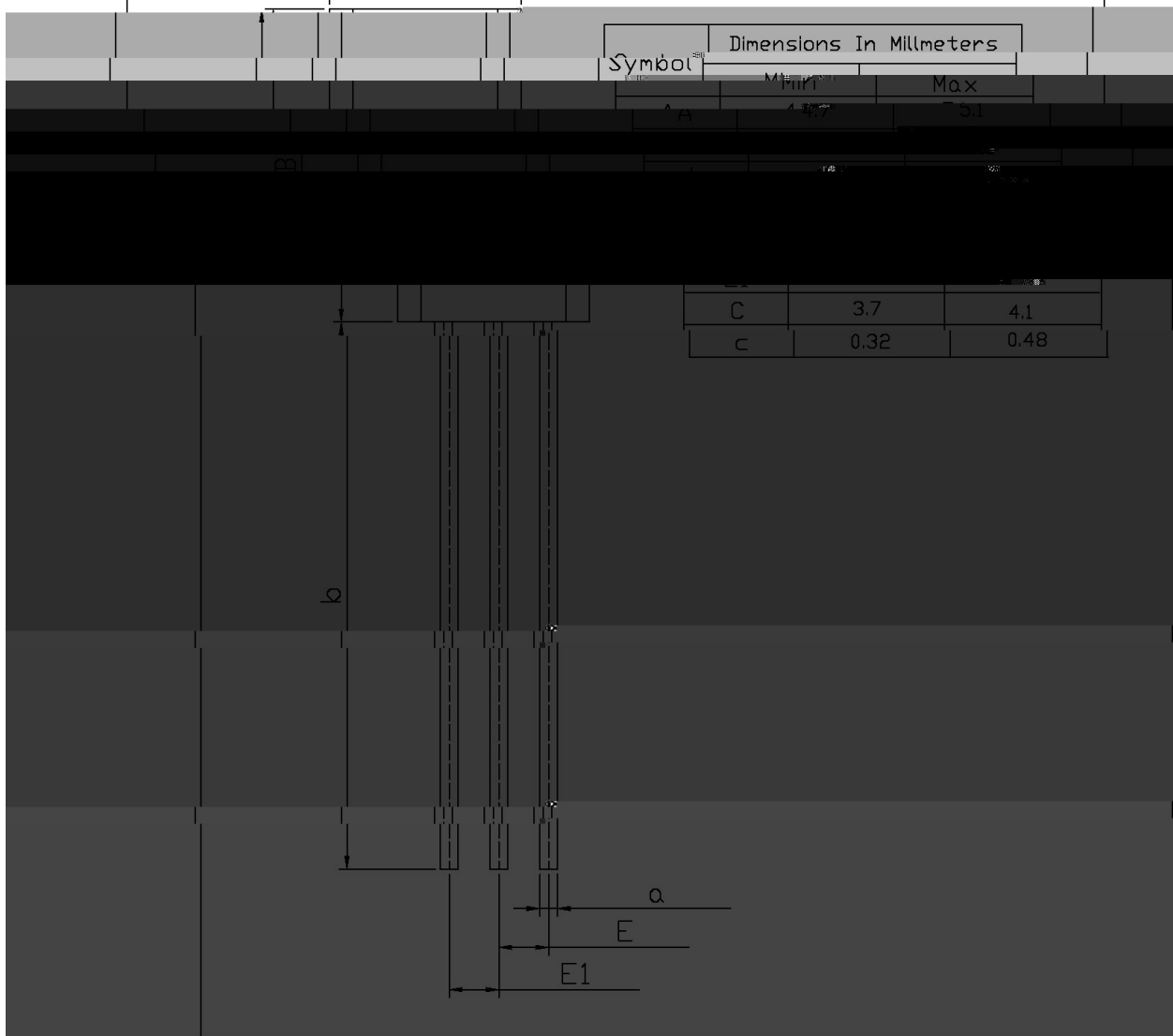
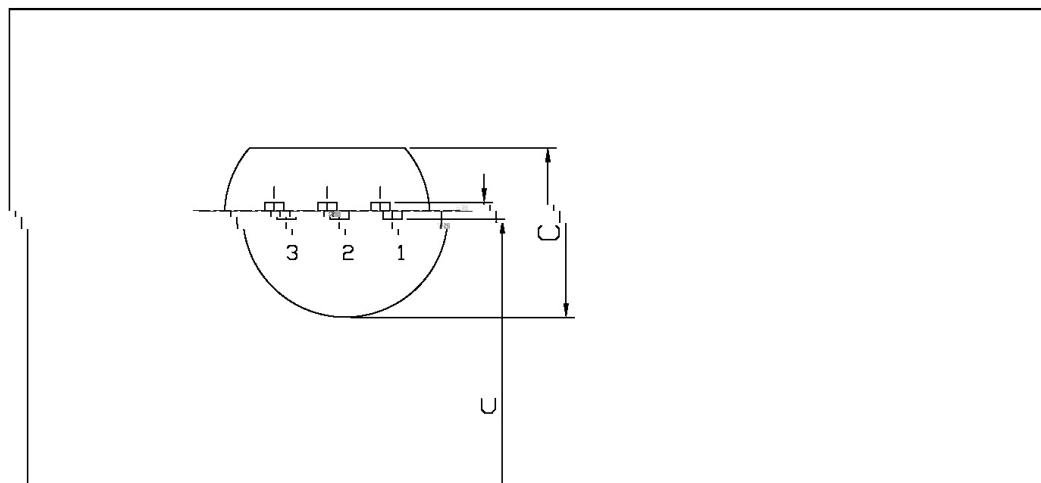

() / Temperature Profile for Dip Soldering(Pb-Free)

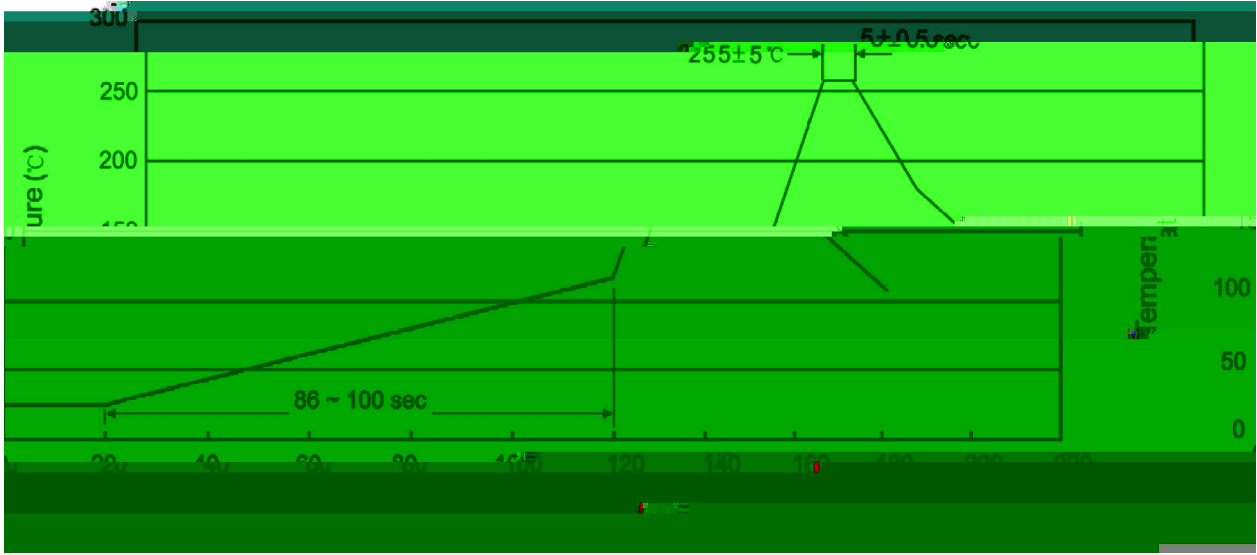

... ..

/ Resistance to Soldering Heat Test Conditions

... ..

/ Packaging SPEC.

封装形式	包装数量					包装尺寸 :		
	Units/Bag 只/袋	Bags/Inner Box 袋/盒	Units/Inner Box 只/盒	Inner Boxes/Outer Box 盒/箱	Units/Outer Box 只/箱	Bag 袋	Inner Box 盒	Outer Box 箱
TO-92LM	1,000	8	8,000	5	40,000	135×190	237×172×102	560×245×195