

2SC2230(A)

Rev.E Mar.-2016

/ Descriptions

KF \$) CD E GE Silicon NPN transistor in a TO-92LM Plastic Package.

/ Features

M <F #

High voltage, high DC current gain.

/ Applications

#

High voltage general amplifier, color TV class B sound output applications

/ Equivalent Circuit

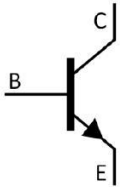

/ Pinning



PIN1 Base PIN 2 Collector PIN 3 Emitter

/ h_{FE} Classifications & Marking

h _{FE} Classifications Symbol	Y	GR
h _{FE} Range	120 240	200 400

2SC2230(A)

Rev.E Mar.-2016

Parameter	Symbol	Rating	Unit
Collector to Base Voltage	V_{CBO}	200	V
Collector to Emitter Voltage	V_{CEO}	2SC2230	160
		2SC2230A	180
Emitter to Base Voltage	V_{EBO}	5.0	V
Collector Current (DC)	I_C	100	mA

/ Electrical Characteristic Curve

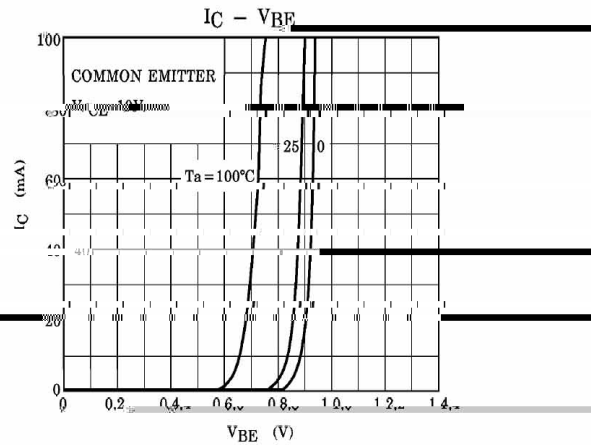
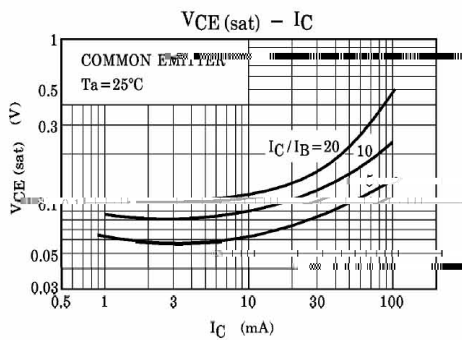
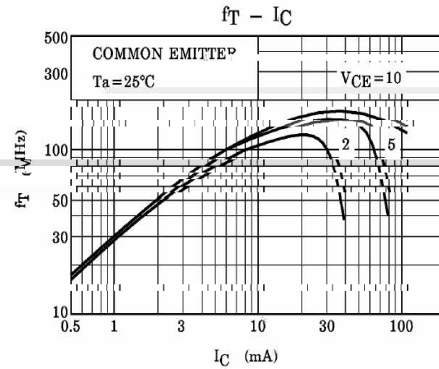
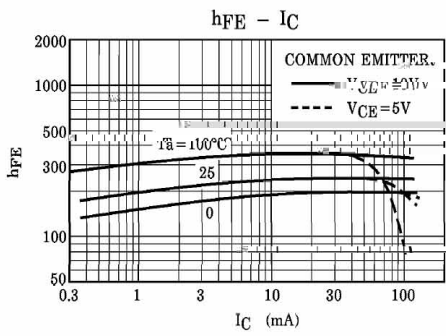
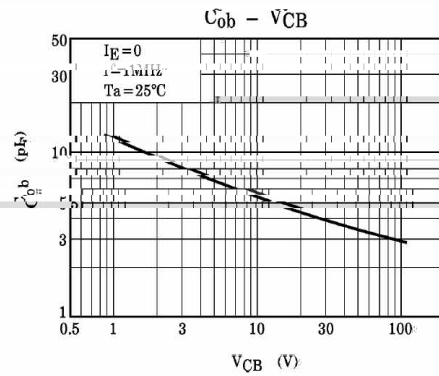
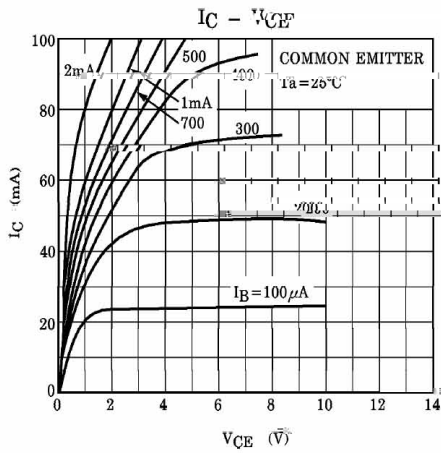

/ Package Dimensions

TO-92LM

Unit: mm

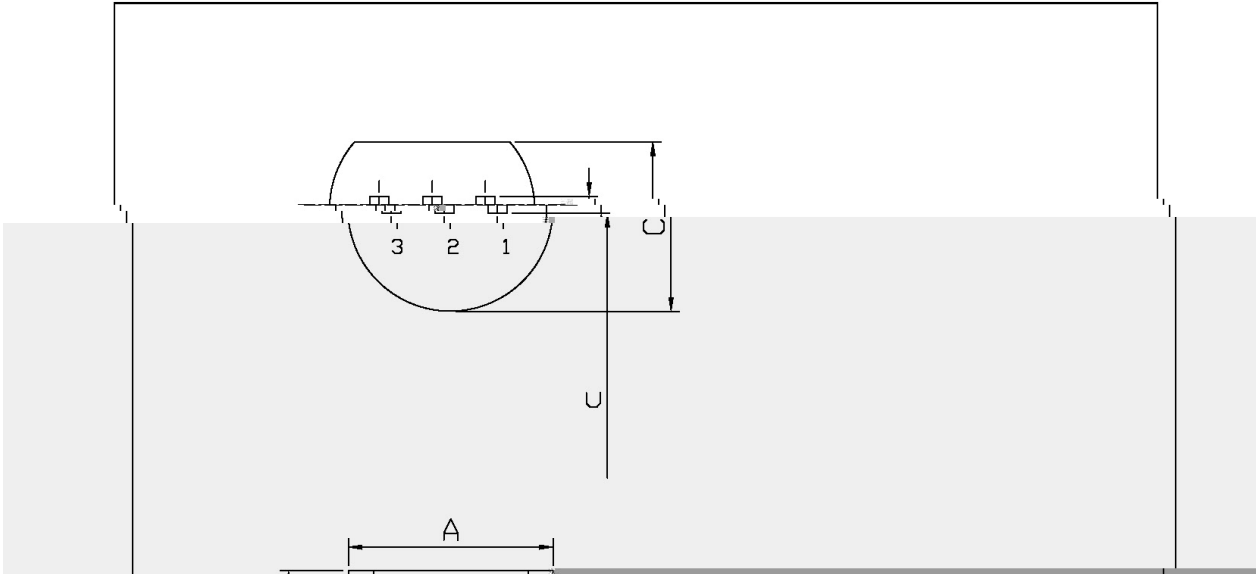

Symbol	Dimensions In Millimeters	
	Min	Max
A	4.7	5.0
B	1.2	1.4
C	0.5	0.6
D	0.5	0.6
E	0.5	0.6
F	0.5	0.6
G	0.5	0.6
H	0.5	0.6
I	0.5	0.6
J	0.5	0.6
K	0.5	0.6
L	0.5	0.6
M	0.5	0.6
N	0.5	0.6
O	0.5	0.6
P	0.5	0.6
Q	0.5	0.6
R	0.5	0.6
S	0.5	0.6
T	0.5	0.6
U	0.5	0.6
V	0.5	0.6
W	0.5	0.6
X	0.5	0.6
Y	0.5	0.6
Z	0.5	0.6

/ Marking Instructions



9| 1
:)) *' 8
P1
!!!!

Note:

- BR: Company Code.
- C2230A: Product Type.
- Y: h_{FE} Classifications Symbol
- ****: Lot No. Code,code change with Lot No.

() / Temperature Profile for Dip Soldering(Pb-Free)

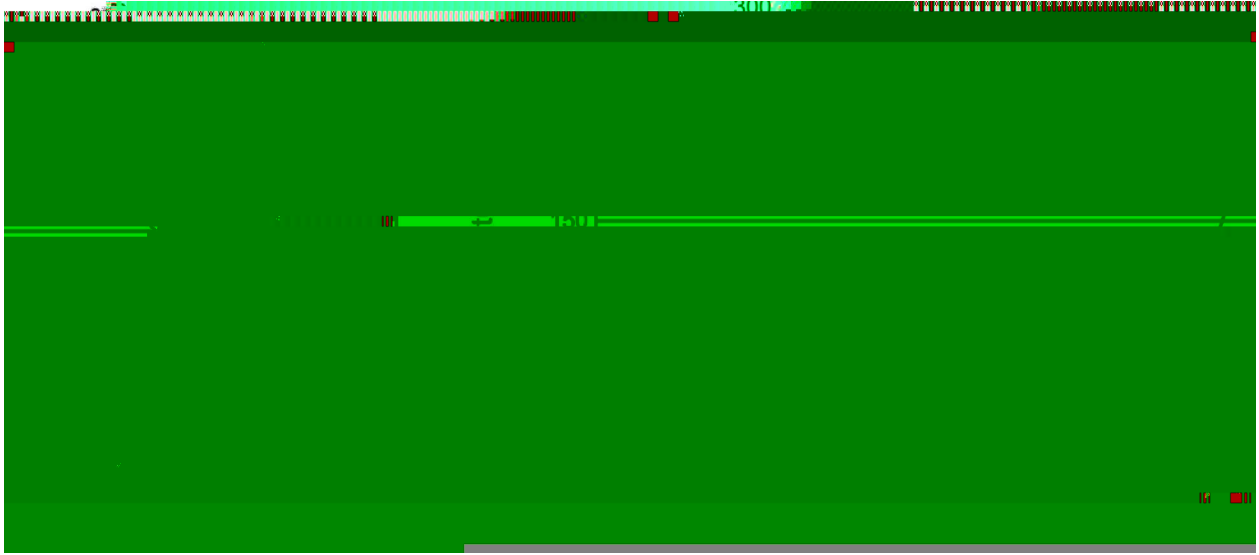

Note:

- | | | | | | |
|---|--------|-----|------------|--------|---|
| 1 | 25 | 150 | 60 | 90sec; | 1.Preheating:25~150 , Time:60~90sec. |
| 2 | 255..5 | | 5..0.5sec; | | 2.Peak Temp.:255..5 , Duration:5..0.5sec. |
| 3 | | 2 | 10 | /sec. | 3. Cooling Speed: 2~10 /sec. |

/ Resistance to Soldering Heat Test Conditions

270..5 10..1 sec. Temp.:270±5 Time:10±1 sec

/ Packaging SPEC.

/ BULK

Package Type 封装形式	Units 包装数量			Dimension 包装尺寸 (unit: mm3)		
	只袋	袋盒	只盒	盒箱	只箱	袋 盒 箱